

REV.	DESCRIPTION	DATE	DRAWN
A	New	10.11.2006	RH
B	frame	23.07.2008	Ronny
C	correct No. of contact	20.04.2011	Ronny
D	general update	09.08.2019	Ronny

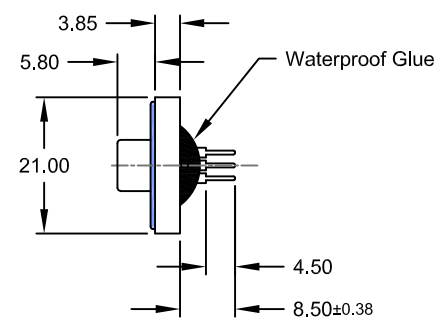

Order Code
SHF-xxx-SIP11-55/TX

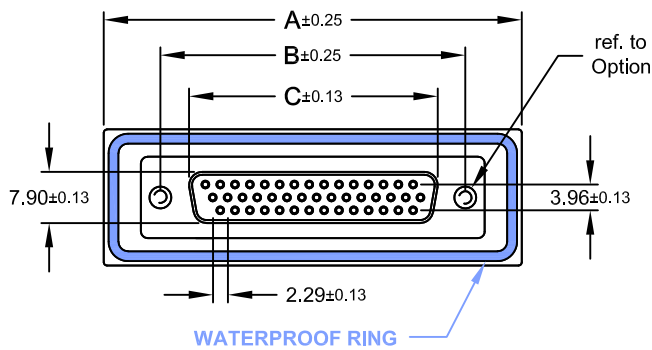
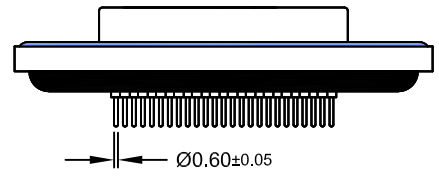

Dimension mm					No. of Contact
A	B	C	D	E	
39,40	24,99	16,33	20,00	28,20	015
47,70	33,30	24,66	28,00	36,50	026
64,50	47,04	38,38	41,50	51,00	044

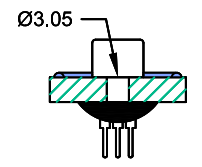

Option: **T0**

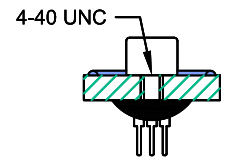

Option: **T**

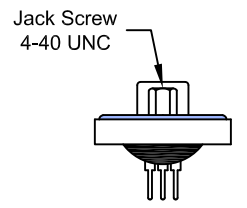

Option: **TJ**
(Jack Screws mounted)

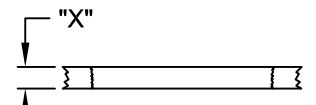

Panel Thickness "X" between 1.20~2.00mm for Screw "L" = 5.70

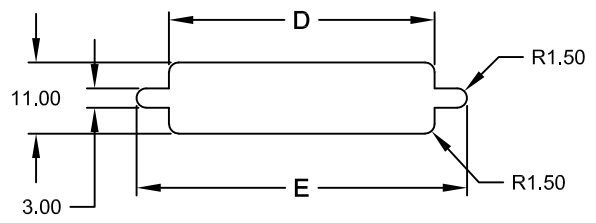
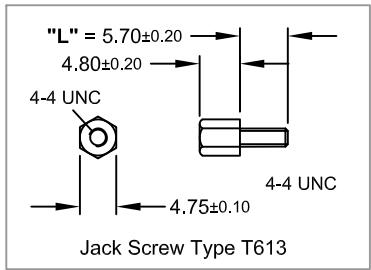

Recommended Panel CUT-OUT

Specifications

Electrical
Current rating: 5A
Insulation resistance: 5000MΩ min.
Contact resistance: 10mΩ max.
Withstanding voltage: 1000V AC rms

Material
Contact: Brass
Plating: Au flash over Ni
Insulator: PBT UL 94V-0
Shell: Steel
Plating: Ni
Operating temperature: -55°C to +85°C

Salt Spray: 48 Hours
Waterproof Rate: IP 67 min.

E-tec 2019 © - all rights reserved

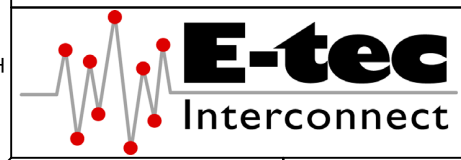

UNIT	GENERAL TOLERANCE		DRAWN	DATE	DWG. NO.	SHEET 1/2
mm	X.° ±	X. ±	RH	10.11.2006	SHF-SIP11/T	REV. D
SCALE	.X° ±	.X ±	CHECK	09.08.2019	SERIES NO.	
Free	.XX° ±	.XX ± 0.25	APPROVE	09.08.2019	SHF-xxx-SIP11-xx/TX	
	.XXX° ±	.XXX ±	Fagi			

Waterproof D-Sub
High Density "Female"
Straight Solder Tail Type

REV.	DESCRIPTION	DATE	DRAWN
A	New	10.11.2006	RH
B	frame	24.07.2008	Ronny
C	general update	09.08.2019	Ronny

RECOMMENDED PCB HOLE LAYOUT "FEMALE"

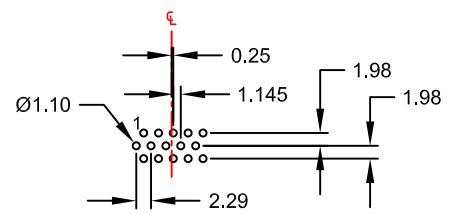

15-contact

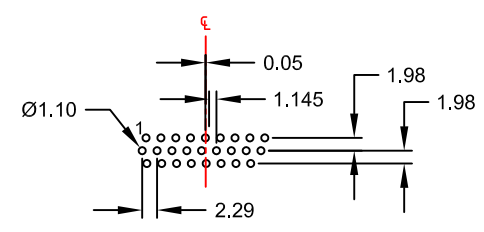

26-contact

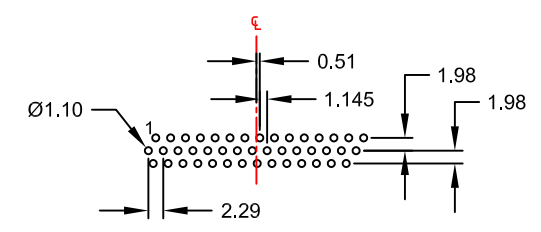

44-contact

Layout Top View
(Tolerance ±0.05)

E-tec 2019 © - all rights reserved



UNIT mm	GENERAL TOLERANCE		DRAWN RH	DATE 10.11.2006	DWG. NO. SHF-SIP11/T	SHEET 2/2		
	SCALE Free	X.° ±				X. ±	CHECK Ronny	DATE 09.08.2019
		.XX° ±	.XX ± 0.25	APPROVE Fagi	DATE 09.08.2019	SERIES NO. SHF-xxx-SIP11-xx/TX		
		.XXX° ±	.XXX ±					

PCB Hole Layout for
Waterproof D-Sub
High Density "Female"
Straight Soldertail Type