

2,54mm pitch **SMT** female header with precision „Jumbo Contact“ for board to board connections.

Accepts square pins 0,65 x 0,65mm max. (Pin Headers), as well as round pins \varnothing 0,65 to 0,85mm max.

The female headers are available in any number of contacts, up to a maximum of 50 for the single row, and 100 for the double row.

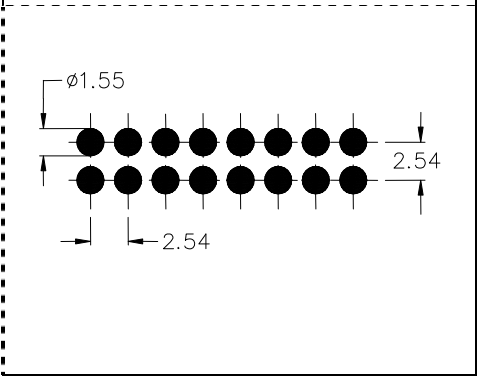
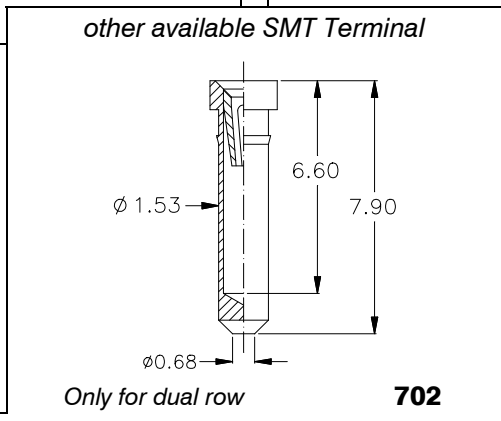
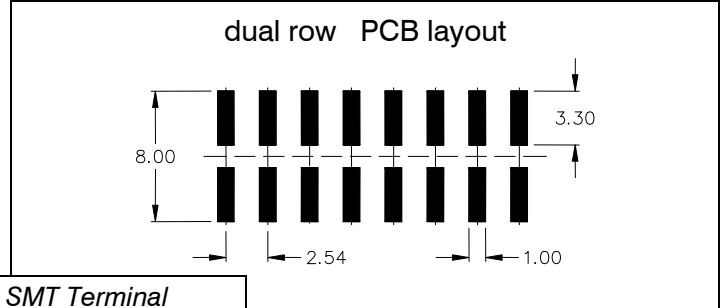
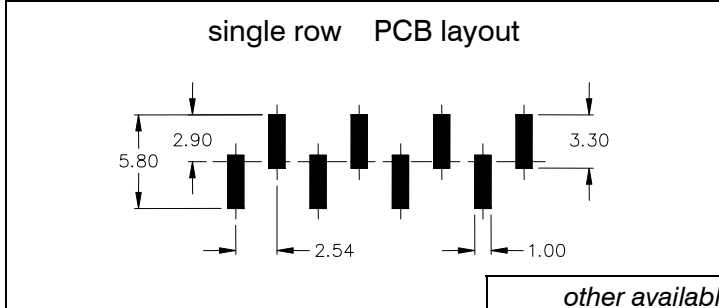
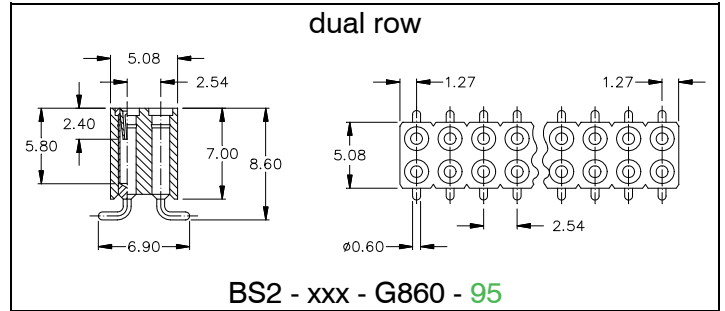
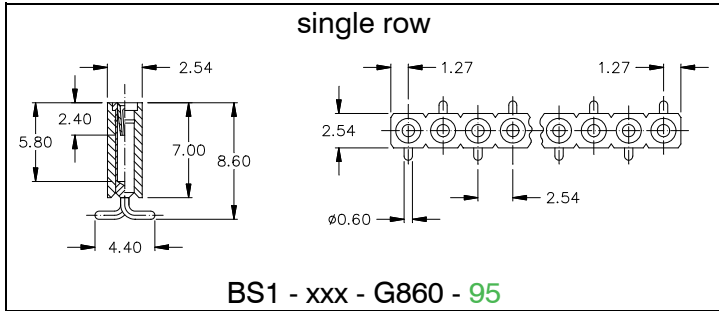
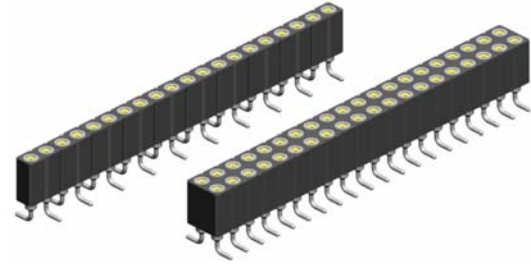

Specifications

Mechanical data

Insertion force (test probe \varnothing 0,66)	2,00 N if Terminal 860
Extraction force (test probe \varnothing 0,66)	1,00 N for all Terminals
Contact life	> 100 cycles
Operating temperature	-55° C to +125° C
Processing Temperature	+250°C +0/-5°C for 20~40sec.

Material

Insulator	(RoHS compliant) high temp plastic UL 94 V-0
Terminal	(RoHS compliant) CuZn
Contact	(RoHS compliant) BeCu

Electrical data

Insulation resistance	10 ⁴ M Ω min.
Breakdown voltage	500 V AC for 1 minute
Contact resistance	30 m Ω / contact max.
Current rating	3 A max., 100V

Insertion depth

maximum	depends on the Terminal style
minimum	4,0mm / .157"

How to order

BSX - xxx - G xxx - xx

